



# ASENNUSOPAS

Club 34F

Club 44F

Club 54F

Club 64FSL

Club 644F

Club 864F

Club 964M

Club 64

Club 64SQ

Club 194T

Club 64CSQ

Club 64C

Club 64CTP

# Club 34F

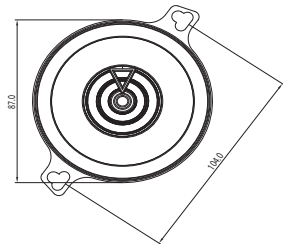
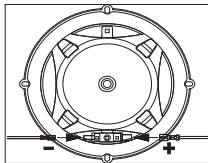
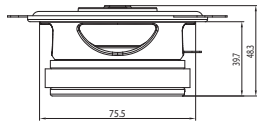

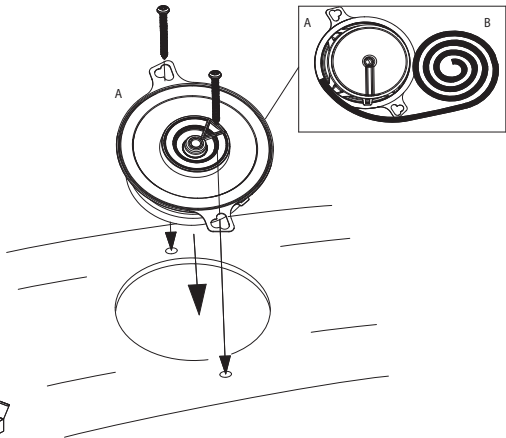
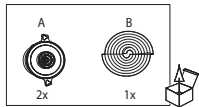

## Tekniset Tiedot

- Tyyppi: 3-1/2" (87 mm) kaksitie-autokaiutin
- Tehonkesto: 25 W RMS, 75 W huippu
- Herkkyys (@ 2,83 V/m): 89 dB
- Taajuusvaste: 90 Hz – 20 kHz
- Nimellisimpedanssi: 3,0 ohmia

## Thiele-Small Parametrit

- BL (Tm): 2,873
- DCR (ohms): 2,26
- Mms (g): 3,723
- Sd (cm<sup>2</sup>): 44,18
- Cms (µm/N): 0,491
- Vas (l): 1,3574
- Fs (Hz): 117,7
- Qes: 0,755
- Qms: 7,777
- Qts: 0,688
- Crossover Point: 4kHz

# Club 44F

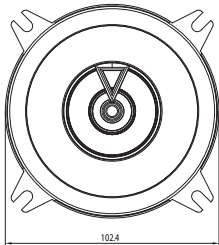
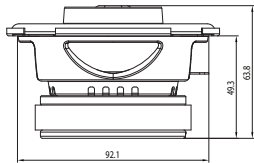
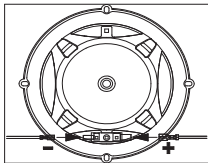

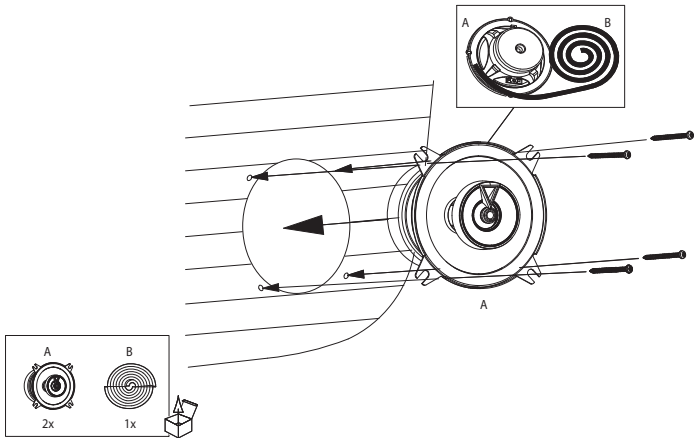

## Tekniset Tiedot

- Tyyppi: 4" (100 mm) kaksitie-autokaiutin
- Tehonkesto: 35W RMS, 105W huippu
- Herkkyys (@ 2,83 V): 90 dB
- Taajuusvaste: 75 Hz – 20 kHz
- Nimellisimpedanssi: 3,0 ohmia

## Thiele-Small Parametrit

- BL (Tm): 3,783
- DCR (ohms): 2,46
- Mms (g): 6,608
- Sd (cm<sup>2</sup>): 63,62
- Cms (μm/N): 0,750
- Vas (l): 4,2937
- Fs (Hz): 71,5
- Qes: 0,510
- Qms: 6,495
- Qts: 0,473
- Crossover Point: 3kHz

# Club 54F

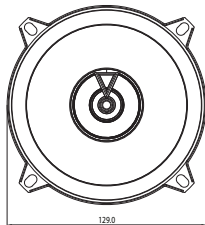
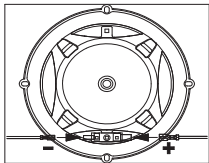
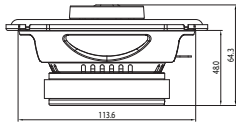



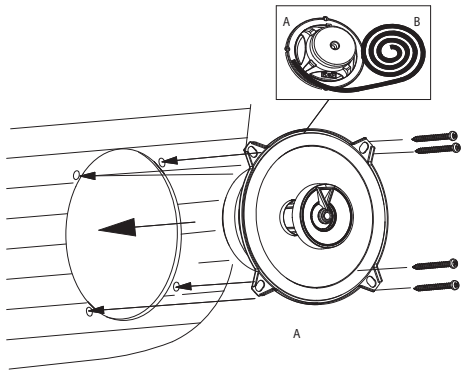
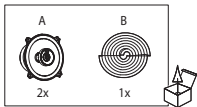

## Tekniset Tiedot

- Tyyppi: 5-1/4" (130mm) kaksitie-autokaiutin
- Tehonkesto: 45W RMS, 135W huippu
- Herkkyys (@ 2,83 V): 91 dB
- Taajuusvaste: 75 Hz – 20 kHz
- Nimellisimpedanssi: 3,0 ohmia

## Thiele-Small Parametrit

- BL (Tm): 3,563
- DCR (ohms): 2,24
- Mms (g): 9,484
- Sd (cm<sup>2</sup>): 103,87
- Cms (µm/N): 0,274
- Vas (l): 4,1850
- Fs (Hz): 98,7
- Qes: 1,036
- Qms: 8,608
- Qts: 0,925
- Crossover Point: 3kHz

# Club 64FSL

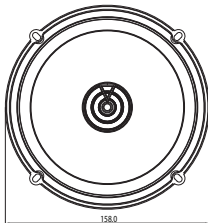
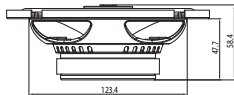
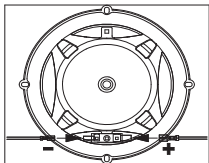

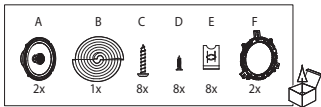
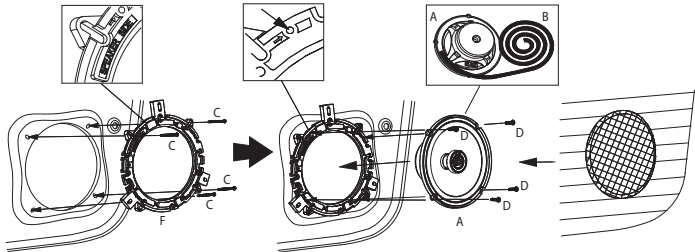

## Tekniset Tiedot

- Tyyppi: Matalaan asennukseen soveltuva 6-1/2" (160 mm) kaksitie-autokaiutin
- Tehonkesto: 55W RMS, 165W huippu
- Herkkyys (@ 2,83 V): 92 dB
- Taajuusvaste: 55 Hz – 20 kHz
- Nimellisimpedanssi: 3,0 ohmia

## Thiele-Small Parametrit

- BL (Tm): 3,739
- DCR (ohms): 2,41
- Mms (g): 9,934
- Sd (cm<sup>2</sup>): 122,72
- Cms (μm/N): 0,278
- Vas (l): 5,9287
- Fs (Hz): 95,7
- Qes: 1,032
- Qms: 11,357
- Qts: 0,946
- Crossover Point: 4kHz

# Club 644F

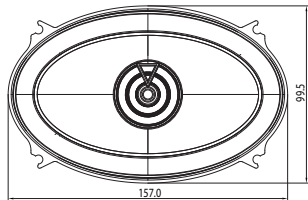
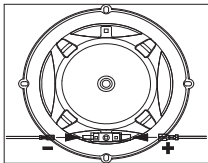
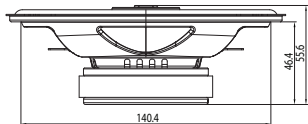

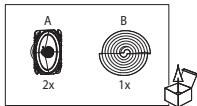
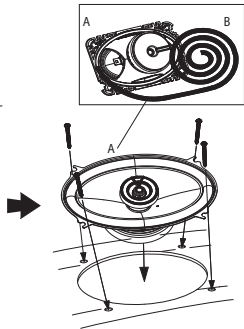
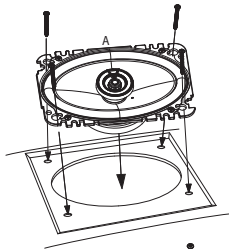

## Tekniset Tiedot

- Tyyppi: 4" x 6" (100 mm x 152 mm) kaksitie-autokaiutin
- Tehonkesto: 40W RMS, 120W huippu
- Herkkyys (@ 2,83 V): 92 dB
- Taajuusvaste: 75 Hz – 20 kHz
- Nimellisimpedanssi: 3,0 ohmia

## Thiele-Small Parametrit

- BL (Tm): 3,296
- DCR (ohms): 2,5
- Mms (g): 7,86
- Sd (cm<sup>2</sup>): 86,59
- Cms (μm/N): 0,245
- Vas (l): 2,5977
- Fs (Hz): 114,7
- Qes: 1,303
- Qms: 12,752
- Qts: 1,182
- Crossover Point: 3kHz



# Club 864F

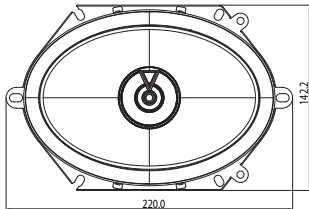
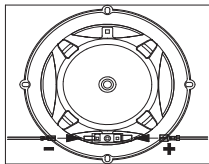
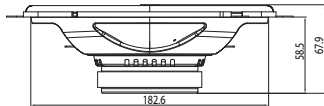

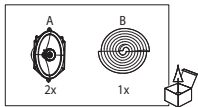
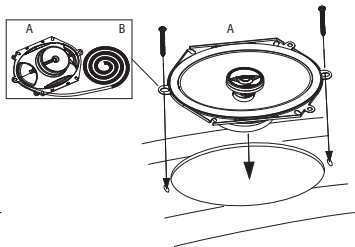
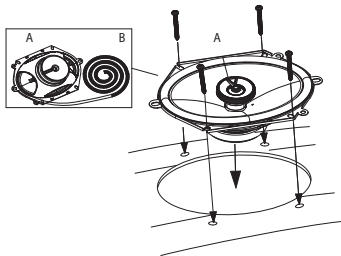

## Tekniset Tiedot

- Tyyppi: 6" x 8" (152 mm x 203 mm) kaksitie-autokaiutin, ei säleikköä
- Tehonkesto: 60W RMS, 180W huippu
- Herkkyys (@ 2,83 V): 93 dB
- Taajuusvaste: 65 Hz – 20 kHz
- Nimellisimpedanssi: 3,0 ohmia

## Thiele-Small Parametrit

- BL (Tm): 3,785
- DCR (ohms): 2,39
- Mms (g): 17,718
- Sd (cm<sup>2</sup>): 165,13
- Cms (µm/N): 0,336
- Vas (l): 12,9798
- Fs (Hz): 65,2
- Qes: 1,210
- Qms: 14,592
- Qts: 1,118
- Crossover Point: 3,5kHz

# Club 964M

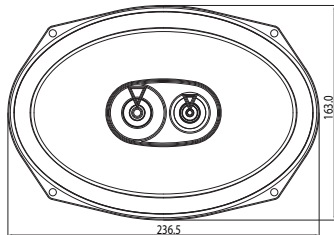
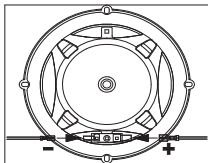
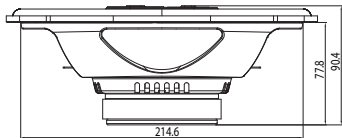

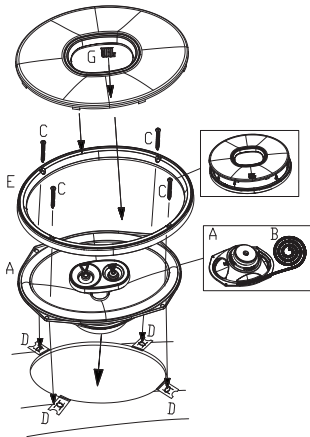
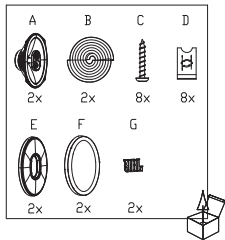

## Tekniset Tiedot

- Tyyppi: 6" x 9" (152 mm x 230 mm) kolmitie-autokaiutin
- Tehonkesto: 85W RMS, 255W huippu
- Herkkyys (@ 2,83 V): 93 dB
- Taajuusvaste: 50 Hz – 20 kHz
- Nimellisimpedanssi: 3,0 ohmia

## Thiele-Small Parametrit

- BL (Tm): 4,063
- DCR (ohms): 2,63
- Mms (g): 23,163
- Sd (cm<sup>2</sup>): 226,98
- Cms (μm/N): 0,337
- Vas (l): 24,5866
- Fs (Hz): 56,9
- Qes: 1,321
- Qms: 11,751
- Qts: 1,188
- Crossover Point: 3kHz

# Club 64

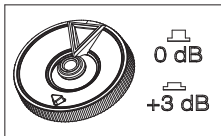
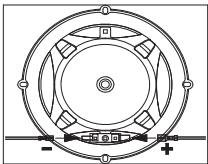

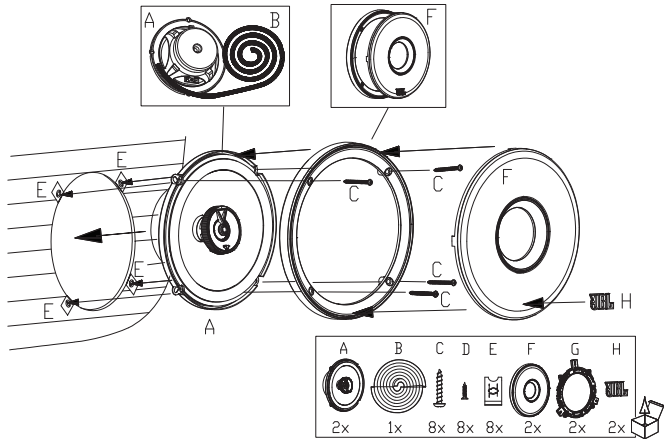



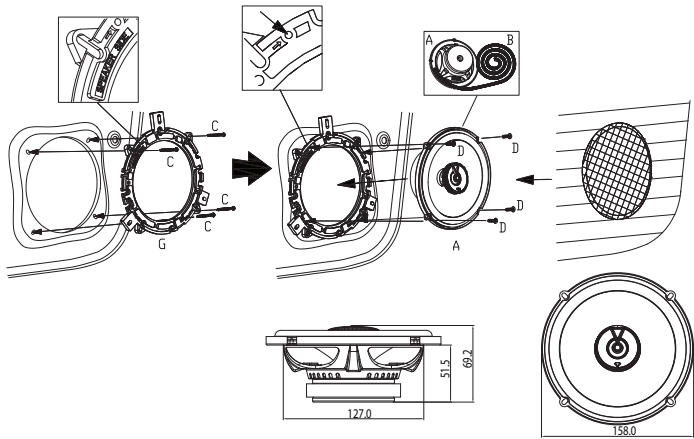

## Tekniset Tiedot

- Tyyppi: 6-1/2" (160 mm) kaksitie-autokaiutin, suunniteltu parantamaan äänentoistoa.
- Tehonkesto: 60W RMS, 180W huippu
- Herkkyys (@ 2,83 V): 93 dB
- Taajuusvaste: 48 Hz – 21 kHz
- Nimellisimpedanssi: 3,0 ohmia

## Thiele-Small Parametrit

- BL (Tm): 3,632
- DCR (ohms): 2,36
- Mms (g): 13,758
- Sd (cm<sup>2</sup>): 132,73
- Cms (μm/N): 0,378
- Vas (l): 9,4253
- Fs (Hz): 69,8
- Qes: 1,080
- Qms: 10,655
- Qts: 0,980
- Crossover Point: 3,5kHz

# Club 64SQ

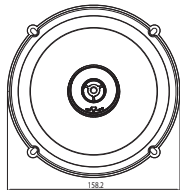
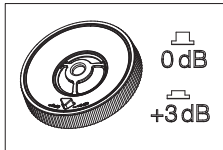
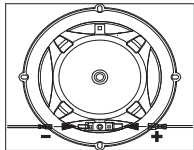
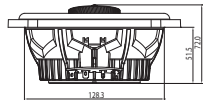

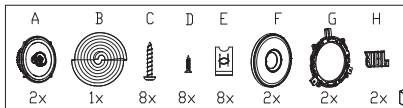
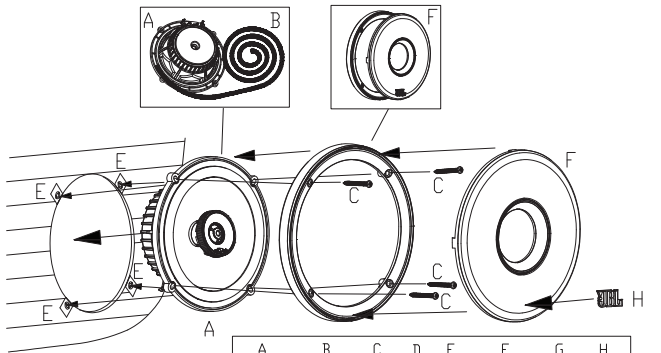

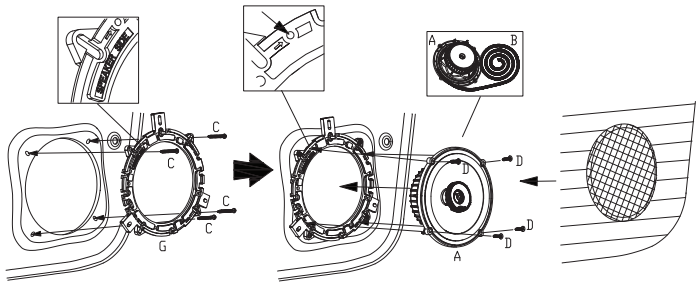

## Tekniset Tiedot

- Tyyppi: 6-1/2" (160mm) 2-tie autokaiutin, suunniteltu ylivertaista äänenlaatua varten.
- Tehonkesto: 75W RMS, 225W huippu
- Herkkyys (@ 2,83 V): 93 dB
- Taajuusvaste: 48 Hz – 21 kHz
- Nimellisimpedanssi: 3,0 ohmia

## Thiele-Small Parametrit

- BL (Tm): 3,748
- DCR (ohms): 2,12
- Mms (g): 12,273
- Sd (cm<sup>2</sup>): 132,73
- Cms (µm/N): 0,530
- Vas (l): 13,2162
- Fs (Hz): 62,4
- Qes: 0,724
- Qms: 9,037
- Qts: 0,671
- Crossover Point: 5 kHz

# Club 194T

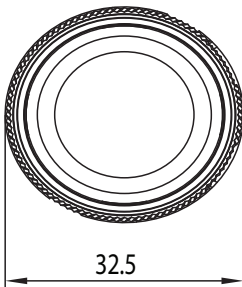
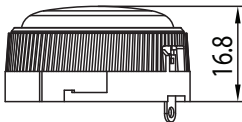

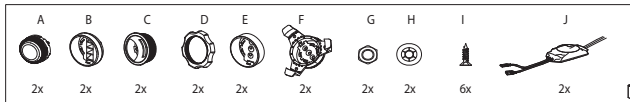
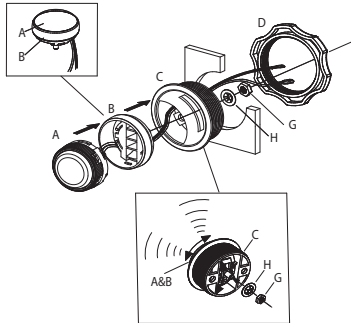
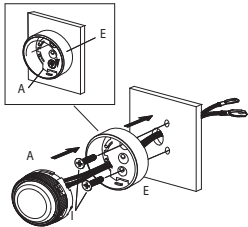



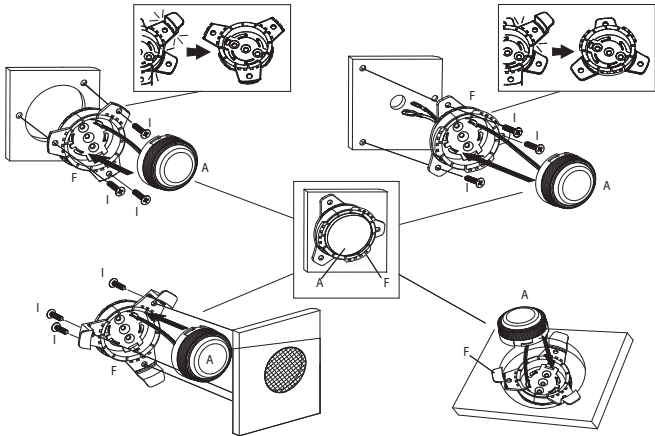

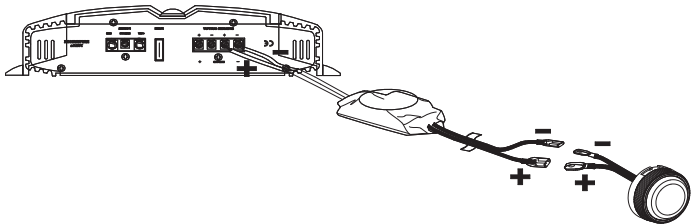

## Tekniset Tiedot

- Tyyppi: 3/4" (19 mm) reunaohjattu diskanttielementtikartio
- Tehonkesto: 50W RMS, 150W huippu
- Herkkyys (@ 2,83 V): 92 dB
- Taajuusvaste: 3 kHz – 20 kHz
- Nimellisimpedanssi: 3,0 ohmia

# Club 64CSQ

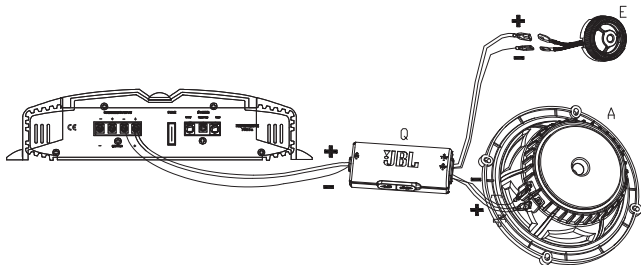
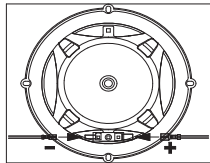

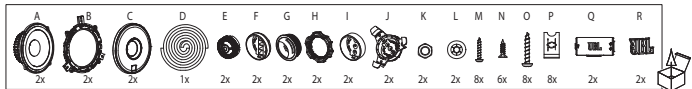
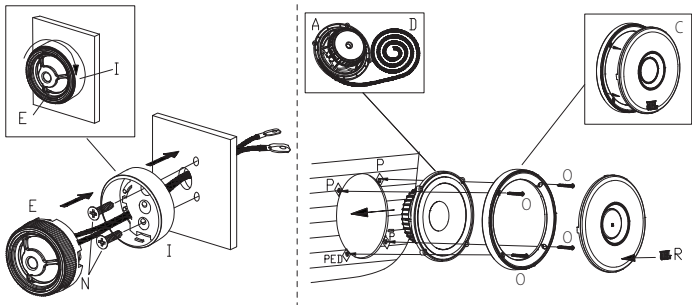

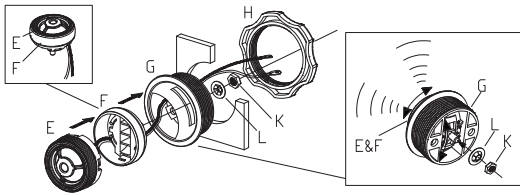
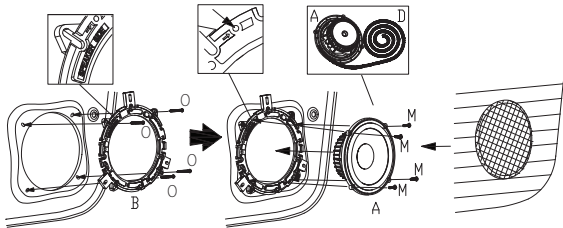

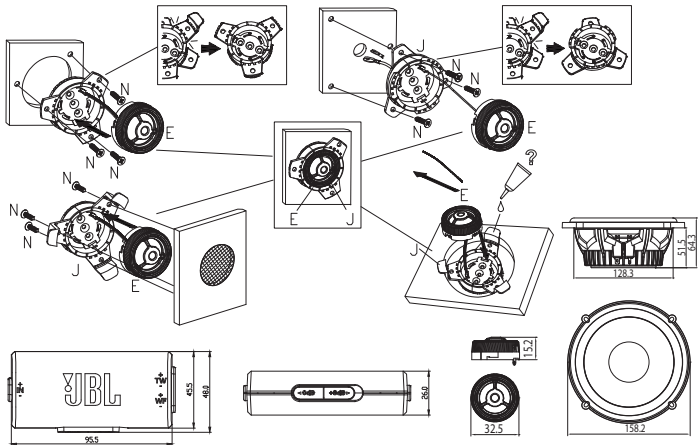

## Tekniset Tiedot

- Tyyppi: 6-1/2" (160mm) 2-tie komponenttikaiutinjärjestelmä, suunniteltu ylivertaista äänenlaatua varten.
- Tehonkesto: 95W RMS, 285W huippu
- Herkkyys (@ 2,83 V): 93 dB
- Taajuusvaste: 48 Hz – 21 kHz
- Nimellisimpedanssi: 3,0 ohmia

## Thiele-Small Parametrit

- BL (Tm): 3,776
- DCR (ohms): 2,09
- Mms (g): 13,238
- Sd (cm<sup>2</sup>): 132,73
- Cms (µm/N): 0,536
- Vas (l): 13,3648
- Fs (Hz): 59,7
- Qes: 0,728
- Qms: 8,315
- Qts: 0,670
- Crossover Point: 5 kHz



# Club 64C

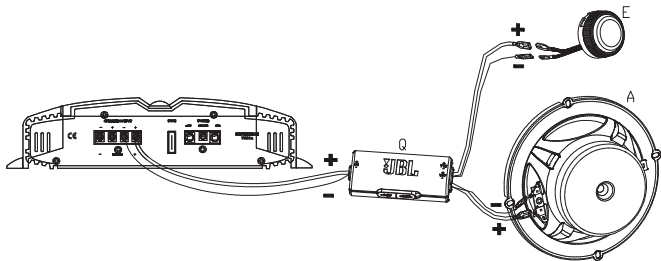
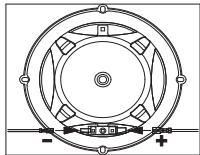

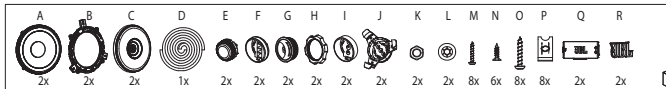
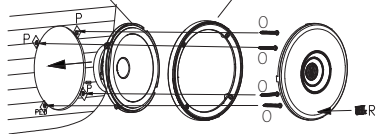
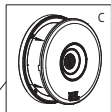
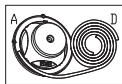
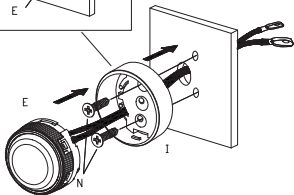
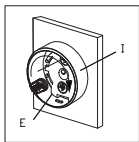

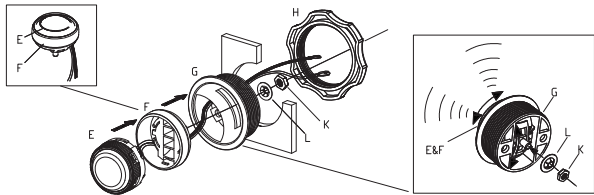
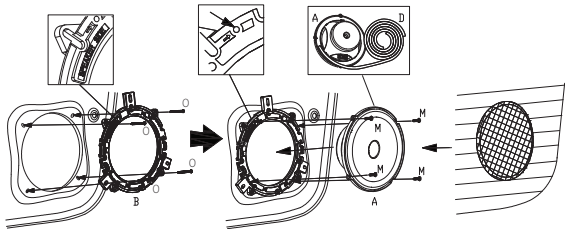

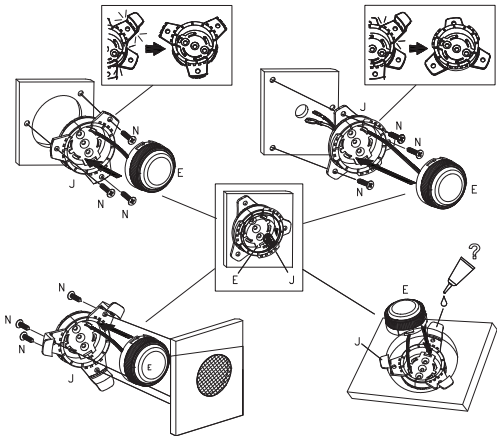

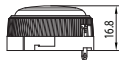
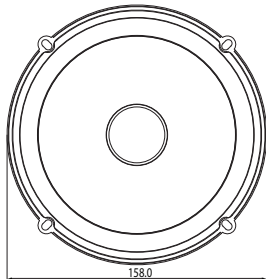
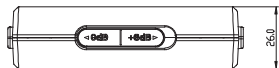
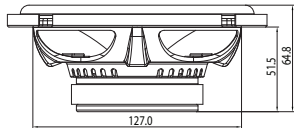
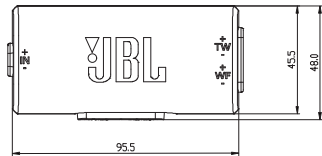

## Tekniset Tiedot

- Tyyppi: 6-1/2" (160 mm) kaksitiekaiutinjärjestelmä
- Tehonkesto: 70W RMS, 210W huippu
- Herkkyys (@ 2,83 V): 92 dB
- Taajuusvaste: 55 Hz – 20 kHz
- Nimellisimpedanssi: 3,0 ohmia

## Thiele-Small Parametrit

- BL (Tm): 3,635
- DCR (ohms): 2,37
- Mms (g): 14,409
- Sd (cm<sup>2</sup>): 132,73
- Cms (μm/N): 0,257
- Vas (l): 6,4107
- Fs (Hz): 82,7
- Qes: 1,340
- Qms: 10,965
- Qts: 1,194
- Crossover Point: 5,5kHz

# Club 64CTP

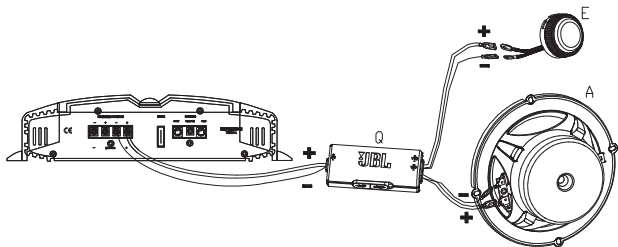
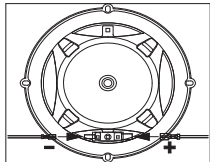

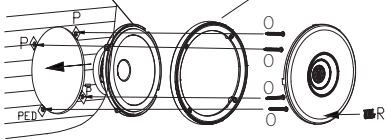
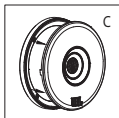
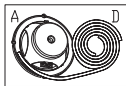
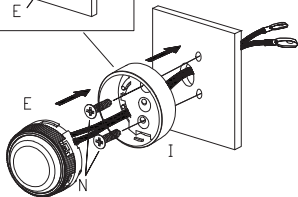
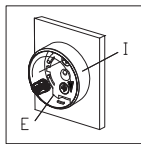



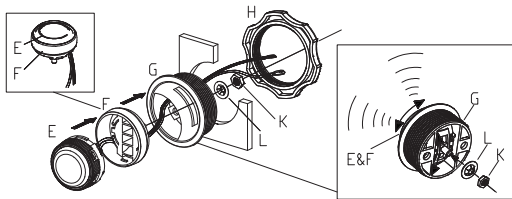
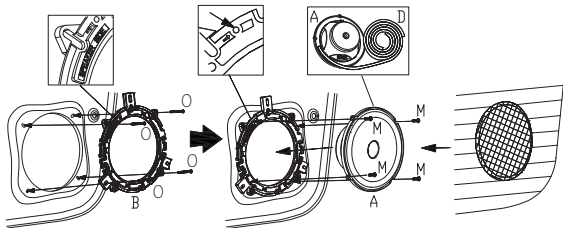

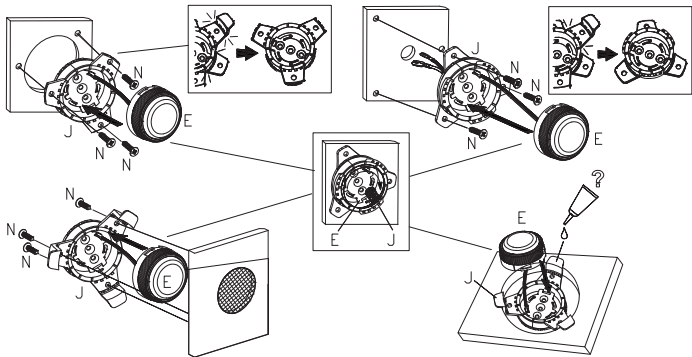

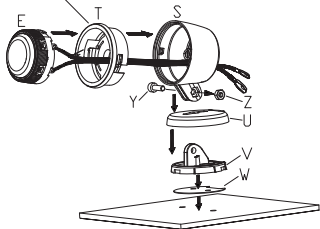
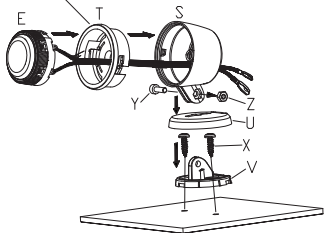

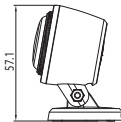
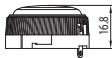
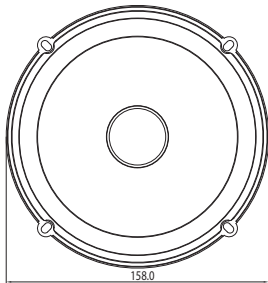
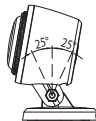
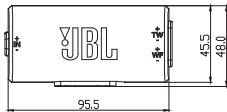
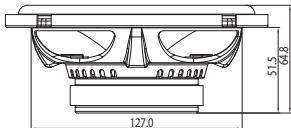

## Tekniset Tiedot

- Tyyppi: 6-1/2" (160 mm) kaksitiekaiutinjärjestelmä diskanttielementtipodilla
- Tehonkesto: 70W RMS, 210W huippu
- Herkkyys (@ 2,83 V): 92 dB
- Taajuusvaste: 55 Hz – 20 kHz
- Nimellisimpedanssi: 3,0 ohmia

## Thiele-Small Parametrit

- BL (Tm): 3,635
- DCR (ohms): 2,37
- Mms (g): 14,409
- Sd (cm<sup>2</sup>): 132,73
- Cms (μm/N): 0,257
- Vas (l): 6,4107
- Fs (Hz): 82,7
- Qes: 1,340
- Qms: 10,965
- Qts: 1,194
- Crossover Point: 5,5kHz



HARMAN International  
Industries, Incorporated  
8500 Balboa Boulevard,  
Northridge, CA 91329 USA

© 2023 HARMAN International  
Industries, Incorporated. Kaikki

oikeudet pidätetään. JBL on HARMAN International Industries,  
Incorporated -yrityksen tavaramerkki, joka on rekisteröity  
Yhdysvalloissa ja/tai muissa maissa.

Toimintoja, teknisiä ominaisuuksia ja ulkomuotoa voidaan  
muuttaa ilmoituksetta.